

Operating instructions

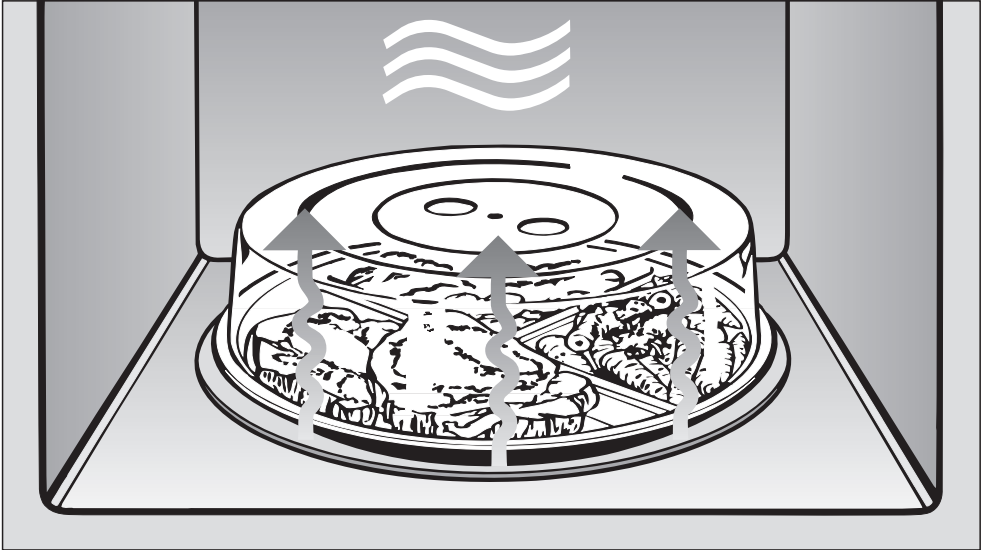

Microwave oven M 635 EG

It is **essential** to read these operating instructions before installing or using the machine, to avoid the risk of accidents or damage to the machine.



Contents

Description of the appliance	4
Caring for the environment	5
Warning and safety instructions	6
How the microwave oven functions	12
Suitable containers for microwave ovens	13
Material and shape	13
Testing dishes for their suitability	15
Accessories	16
Accessories supplied	16
A cover	16
Grilling rack	16
Glass tray	16
Optional accessories	17
Gourmet plate (MGP 24)	17
Preparation for use	18
Setting time of day	18
Altering the time of day	18
Switching off the time of day display	18
Night time	18
Minute minder	18
To open the door	19
To close the door	19
Audible tone	19
Safety lock	19
Operation	20
Types of operation	20
Microwave-Solo mode	20
Microwave power settings	20
Times for defrosting, reheating, cooking	20
Placing the container in the oven	21
Turntable	21
Starting a process	22
Interrupting a process / Re-starting a process	22
Altering settings	22
To cancel a process	22
Automatic "warming" function	23
Quick-Start (programmable)	23

Programming the end of cooking time.	24
Reheating	25
Cooking	26
Defrosting / Defrosting and reheating / cooking	27
Practical tips	28
Grilling	29
Combination mode - Microwave + Grill	30
Automatic programmes	31
Cleaning and care	32
Problem solving guide	35
After Sales Service	37
Electrical connection	38
Electrical connection U.K.	38
Electrical connection AUS / NZ	40
Installation and connection	41
Technical data	42

Description of the appliance

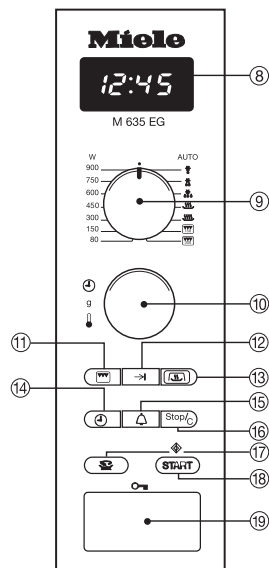
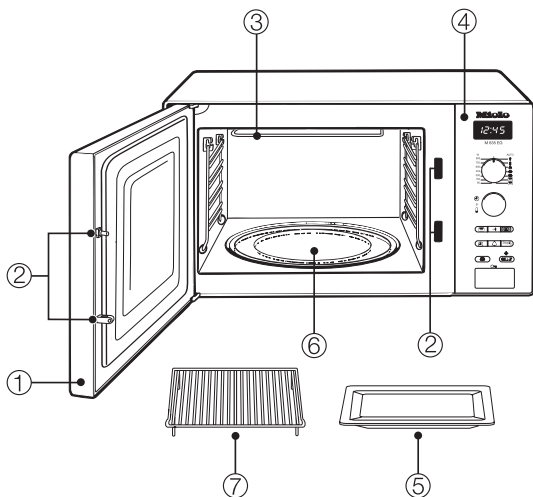

- ① Appliance door
- ② Door lock
- ③ Grill / browning element
- ④ Control panel
- ⑤ Glass tray
- ⑥ Turntable
- ⑦ Grilling rack
- ⑧ Electronic clock with display
- ⑨ Selector switch for microwave-power levels and automatic programmes
- ⑩ Rotary selector: time, weight, temperature, grill setting
- ⑪ Grill button
- ⑫ Button for programming end of cooking time \rightarrow
- ⑬ Automatic warming function button
- ⑭ Time of day button \odot
- ⑮ Minute minder button \triangle
- ⑯ Stop / cancel button
- ⑰ Turntable button
- ⑱ START/Quick-Start (programmable)
- ⑲ Door release button

Using the microwave oven

- Food can be defrosted, re-heated or cooked by entering a power setting and a time.
- Deep frozen ready-made meals can be defrosted and then re-heated or cooked.
- The microwave oven can also be used for other tasks, e.g. for proving dough, melting chocolate and butter, dissolving gelatine etc.

Disposal of the packing material

The transport and protective packing has been selected from materials which are environmentally friendly for disposal and can normally be recycled.

Ensure that any plastic wrappings, bags etc. are disposed safely and kept out of the reach of babies and young children. Danger of suffocation!

Rather than just throwing these materials away, please ensure they are offered for recycling.

Disposal of your old appliance

Old appliances may contain material which can be reclaimed or recycled. Please contact your dealer, your local waste collection centre or scrap merchant about potential recycling schemes.

Ensure that the appliance presents no danger to children while being stored for disposal.

See the appropriate section in the Warning and Safety instructions.

Warning and safety instructions

This appliance complies with all relevant legal safety requirements. Before installation and before using the appliance for the first time, read the operating instructions carefully. They contain important notes on installation, safety, operation and care of the appliance. This way you will avoid the risk of accidents and damage to the appliance. Keep these instructions in a safe place and pass them on to any future user.

Correct usage

■ The appliance is intended for domestic use only to defrost, reheat, cook and to grill food: Any other usage is not supported by the manufacturer and could be dangerous. The manufacturer cannot be held responsible for damage caused by improper use of the appliance.

■ Never use the microwave to store or dry items which could ignite easily. Fire hazard!

■ Do not let children access the appliance or its controls. Supervise its use by older children, the elderly or infirm. Please ensure that they are aware of how a microwave oven works and understand the dangers of improper use.

Technical safety

■ Do not use the microwave if

- the door is warped.
- the door hinges are loose.
- holes or cracks are visible in the casing, the door, the door seal or the oven interior walls.

Operating the appliance with this type of damage will result in microwave leakage, and present a hazard to the user.

■ Repairs may only be carried out by a suitably qualified and competent person in accordance with national and local safety regulations. Repairs and other work by unqualified persons could be dangerous. The manufacturer cannot be held responsible for unauthorised work.

■ Never open the casing of the appliance.

Tampering with electrical connections or components and mechanical parts is highly dangerous to the user and can cause operational faults or electric shock.

■ If the connection cable is damaged the new cable must be fitted by a Miele approved service technician.

■ Before connecting the appliance to the mains supply make sure that the rating on the data plate corresponds to the voltage and frequency of the household supply. This data must correspond in order to avoid risk of damage to the appliance. Consult a suitably qualified person if in doubt.

Warning and safety instructions

■ The electrical safety of this appliance can only be guaranteed when continuity is complete between the appliance and an effective earthing system, which complies with local and national safety regulations. It is most important that this basic safety requirement is present. If in any doubt, the electrical wiring should be checked by a qualified electrician.

The manufacturer cannot be held liable for the consequences of an inadequate earthing system (e.g. electric shock).

■ The appliance is only completely isolated from the electricity supply when:

– it is switched off at the wall socket and the plug removed.

Do not pull on the cable, only on the plug.

– the mains fuse is withdrawn.

– or the screw-out fuse is removed (in countries where this is applicable).

■ Do not connect the appliance to the mains electricity supply by an extension lead.

Extension leads do not guarantee the required safety of the appliance, (e.g. danger of overheating).

■ Ensure that current is not supplied to the appliance while maintenance or repair work is being carried out.

■ This equipment is not designed for maritime use or for use in mobile installations such as caravans, aircraft etc. However it may be suitable for such usage subject to a risk assessment of the installation being carried out by a suitably qualified engineer.

Use

■ Always ensure that food is sufficiently heated.

Many factors will affect the overall cooking time, including the size and amount of food, its initial temperature, changes to the recipe and the shape and size of cooking container.

Some foods may contain micro organisms which are only destroyed by thorough cooking, therefore when cooking or reheating foods, e.g. poultry, it is particularly important that food is fully cooked through (at temperatures over 70 °C for at least 10 minutes). If in doubt select a longer cooking or reheating time.

■ It is important that the heat is allowed to spread evenly throughout the food being cooked.

This can be achieved by stirring and/or turning the food, and by observing a sufficiently long standing time, which should be added to the time needed for cooking, re-heating or defrosting.

■ Always remember that times for cooking, reheating and defrosting are usually considerably shorter than with traditional methods of food preparation.

Excessively long cooking times can lead to food drying out and burning, or could even cause it to catch fire. There is also a danger of fire if breadcrumbs, flowers, herbs, etc., are dried in the microwave oven. Always ensure that this type of procedure is supervised.

Warning and safety instructions

Do not use the microwave to heat up herb cushions or pads filled with wheat grains or lavender, such as those used in aromatherapy. These pads can ignite when heated even after they have been removed from the microwave.

Fire hazard!

Exercise caution when cooking or reheating food with a high sugar content, e.g. Christmas pudding. If heated for too long the sugar may caramelize or ignite.

Do not use full power if you warm empty dishes or dry herbs. The lack or minimum amount of food could cause damage to the appliance.

Never cook or reheat food or liquids in sealed containers or bottles.

With baby bottles the screw top and teat must be removed.

Otherwise pressure builds up which can cause the bottle or container to explode posing a severe risk of injury.

Before serving remember to allow a sufficient standing time and then always check the temperature of the actual food itself after taking it out of the microwave. Do not be misled by the temperature of the container which does not necessarily give a correct indication of the temperature of the food or liquid in it. **This is particularly important when preparing food for babies, children, and the elderly or infirm.**

When heating liquids, the boiling rod provided should be placed into the container.



When heating liquids, milk, sauces etc., in the oven without the boiling rod, the boiling point of the liquid may be reached without the production of typical bubbles. The liquid does not boil evenly throughout. This so-called 'boiling delay' can cause a sudden build up of bubbles, when the container is removed from the oven or shaken. This can lead to the liquid boiling over suddenly and explosively. Danger of burning!

The formation of bubbles can be so strong that the pressure forces the oven door open. The user could be injured and the appliance damaged.

The boiling rod ensures that the liquid boils evenly and that bubbles form at an early stage during the operation.

Warning and safety instructions

■ If smoke occurs in the oven interior, to avoid fuelling any flame do not open the oven door.

Interrupt the process (by pressing the Stop/C button twice). Switch off at the wall socket and where applicable, remove the plug. Do not open the oven door until the smoke has dispersed.

■ Never heat undiluted alcohol in the microwave oven as this can easily ignite. This is a fire hazard.

■ Do not heat up tins in the microwave oven. Pressure can build up and they may explode. This could result in injury or damage.

■ Do not use any containers or cutlery made from or containing metal, aluminium foil, lead crystal glassware, temperature-sensitive plastics, wooden utensils or cutlery, metal clips or wire ties. Do not use bowls with milled rims, or cream pots with the foil lid only partially removed.

Such items could be damaged, or cause a fire hazard.

The rack supplied with the appliance is designed to be compatible with microwaves, and can therefore be used for grilling with or without the microwave function.

■ Do not leave the oven unattended when reheating or cooking food in disposable containers made of plastic, paper or other inflammable material. Before using single use containers make sure they are suitable for use in microwave ovens. See appropriate section.

■ Eggs can only be cooked in their shells in the microwave oven in a specially designed egg-boiling device available from specialist shops. Similarly, hard-boiled eggs should not be reheated in the microwave as this may lead to the eggs bursting, even once they have been removed from the oven.

■ Eggs can be cooked without their shells in the microwave oven only if the yolk membrane has been punctured several times first. The pressure could otherwise cause the egg yolk to explode. Danger of injury.

■ Food with a thick skin or peel, such as tomatoes, sausages, jacket potatoes and aubergines, should be pierced or the skin cut in several places before cooking to allow steam to escape and prevent the food from bursting.

■ Do not reheat food in the oven in heat-retaining bags, such as those used for ready grilled chicken or naan bread from take-aways which are intended for use in normal ovens. These heat-retaining bags usually contain a thin layer of aluminium foil which reflects microwaves. This reflected energy can, in turn, cause the outer paper covering to become so hot that it ignites.

Warning and safety instructions

Always ensure that food or a browning dish has been placed in the microwave, and that the turntable is in place, before switching on.

Do not leave the oven unattended when cooking with oils and fats as these can be a fire hazard if allowed to overheat.

Ovenproof earthenware can retain a considerable amount of moisture. Earthenware and porcelain containers with hollow handles and lid knobs must only be used in this oven if they have vent holes which allow the moisture to escape. Without vent holes there can be a pressure build-up, causing the container to crack or shatter, with the danger of injury.

With all functions except microwave solo mode the rack, oven interior, grill element, side runners, door and housing can get hot! Do not let small children touch the oven while it is in operation, there is the danger of being burnt. Supervise its use by the elderly or infirm.

Wear oven gloves when taking dishes in and out of the oven, or when handling dishes or food in the oven if the grill is on or has just been in operation. Danger of burning.

The rack and glass tray get hot during grilling (with and without microwave). Danger of burning.

Only use the baking tray with the fan heat function. It must not be used with the microwave function.

Never place the hot glass tray (or any other hot cooking containers) on a cold surface, such as a tiled or granite worktop. The glass tray or container could crack or shatter, and the worktop surface could be damaged. Use a heat-resistant mat or wire cooling rack.

Do not use the oven to heat up the room. Due to the high temperatures radiated, objects left near the oven could catch fire.

Do not use the appliance as a resting place for other items. The heat from the top of the appliance could cause some kinds of items to melt.

To check the temperature of the food, first interrupt the cooking process. Then use a thermometer specifically approved for food use to measure the temperature of the food. Never use a thermometer containing mercury or liquid, as these are not suitable for use with very high temperatures and will break very easily.

Never use a steam-cleaning appliance to clean this appliance. Pressurised steam could reach the electrical components and cause a short circuit.

In countries where there are areas which may be subject to infestation by cockroaches or other vermin, pay particular attention to keeping the appliance and its surroundings in a clean condition at all times. Any damage which may be caused by cockroaches or other vermin will not be covered by the appliance guarantee.

Warning and safety instructions

When using browning dishes:

■ Always use oven gloves when handling the browning dish to avoid burns.

■ Never place the browning dish directly on to a table or work surface. Use a suitable heat-resistant mat, grid or board to protect the work surface or table and prevent heat-marks.

■ Browning dishes should only be used in a microwave oven, or as a serving dish.

In a conventional oven the special glaze would get damaged.

Disposal of your old appliance

■ Before disposing of your old appliance first make it unusable. Cut off and render any plug unusable. Cut off the cable directly behind the appliance to prevent misuse. This should be done by a competent person.

The manufacturer cannot be held liable for damage caused by non-compliance with these Warning and Safety instructions.

How the microwave oven functions

In the microwave oven, food is cooked, reheated or defrosted quickly.

How does the microwave oven function?

In a microwave oven there is a high-frequency tube called a magnetron. This converts electrical energy into microwaves. These microwaves are distributed evenly throughout the oven interior and rebound off the metal sides of the oven interior to reach the food from all sides. Microwave distribution is improved with the turntable engaged.

In order for microwaves to reach the food, they must be able to penetrate the cooking utensil being used. Microwaves can penetrate porcelain, glass, cardboard and plastics but not metal. Do not, therefore, use utensils made of metal, or which contain metal, for example in the form of gold or silver trim. The metal reflects the microwaves and this could lead to the creation of sparks. The microwaves cannot be absorbed.

Microwaves pass through a suitable container and find their way directly into the food. All food contains moisture molecules which, when subjected to microwave energy, start to oscillate 2.5 thousand million times a second. The friction caused by this vibration creates heat, which first starts developing around the outside of the food and then slowly penetrates towards the centre. The moisture, fat and sugar content of food will affect the speed at which it is cooked.

As heat is produced directly in the food,

- food can generally be cooked without adding much liquid or cooking oil.
- cooking, reheating and defrosting in a microwave oven is quicker than using conventional methods.
- nutrients, such as vitamins and minerals, are generally retained.
- colour, texture and taste of food are not impaired.

Microwaves stop being produced as soon as the cooking process is interrupted or the appliance door is opened. When the appliance is in operation, the closed, sealed door prevents microwaves escaping from the appliance.

Suitable containers for microwave ovens

Microwaves

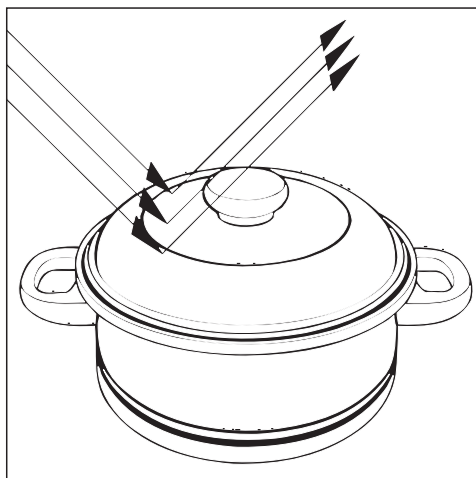

- are reflected by metal,

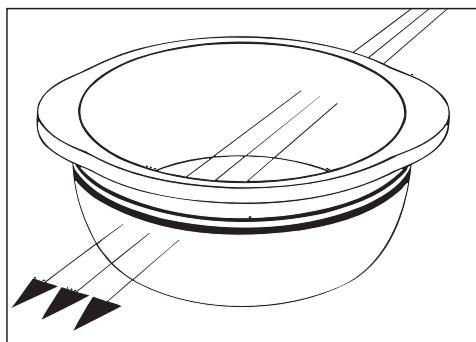

- pass through glass and chinaware,

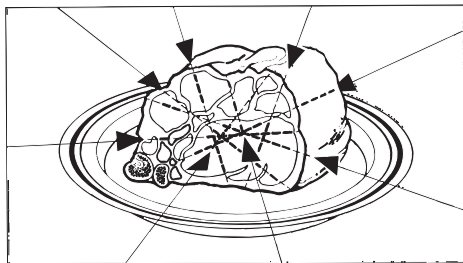

- and are absorbed by food.

Material and shape

The material and shape of containers used affect cooking results and times. Heat distribution is more even in round and oval shaped flat containers than in rectangular containers, providing better results.

Metal

Metal containers, aluminium foil and metal cutlery, or china with metallic decoration, such as gold rims or cobalt blue must not be used in an oven being used in microwave mode.

The metal reflects the microwaves, hindering the cooking process.

Exceptions:

- If recommended by the producer, pre-cooked meals packed in aluminium foil containers can be defrosted and reheated in the microwave oven. Important: Remove the lid first.

However, as food is only heated from the top it is better to remove the food from the aluminium foil container and transfer it to a dish suitable for a microwave oven. The heat distribution will be more even.

If sparks and arcing occur when using an aluminium container, stop and transfer the food to a microwave safe container.

Suitable containers for microwave ovens

- For even defrosting and to avoid overcooking unevenly shaped cuts of meat, poultry or fish, small pieces of aluminium foil may be used to mask wingtips or other thin parts for the last few minutes of the process.

Make sure that the aluminium foil is at least 2 cm from the oven walls at all times. It must not touch the walls.

- Metal meat skewers or clamps should only be used if they are very small in comparison to the size of the cut of meat.

Glassware

Heat-resistant glass or ceramic glass are ideal for use in the microwave oven.

Crystal glass contains lead which could cause the glass to crack. Glass dishes with a milled rim are also subject to this risk. Both are unsuitable.

Porcelain (chinaware)

Porcelain (chinaware) is a suitable material.

Do not use porcelain with gold or silver edging or items with hollow knobs or handles, as insufficient ventilation may cause pressure.

Earthenware

Decorated earthenware is only suitable if the decoration is beneath an all-over glaze.

Earthenware can get very hot, and may crack.

Glazes and colours

Some glazes and colours contain metal.

This makes them unsuitable for use in a microwave oven.

Plastics

Plastic containers must only be used for microwave mode alone. Plastics must be heat-resistant to a minimum of 110 °C.

Otherwise the plastic may melt and fuse with the food.

Special plastic utensils, designed for use in microwave ovens are available from good retail outlets.

Melamine is not suitable as it absorbs energy and heats up.

Disposable containers, such as trays made from polystyrene, can only be used for very short timed warming and reheating of food.

When purchasing new containers, make sure that they are suitable for use in a microwave oven.

Plastic boiling bags can be used for cooking and reheating.

They should be pierced beforehand so that steam can escape. This prevents a build-up of pressure and reduces the risk of the bag bursting.

Suitable containers for microwave ovens

Roasting bags and **tubes** can also be used. Roasting tubes should be about 40 cm longer and roasting bags about 20 cm longer than the food being roasted, and carefully tied with string. Turn the ends over and secure them. The bag should be pierced according to the manufacturer's instructions.

Do not use metal clips or wire ties, even if bound by paper.

There is a danger that they will ignite when heated.

Wood

Wooden dishes are not suitable.

Moisture contained in the wood evaporates when exposed to microwave energy, causing the wood to dry and crack.

Disposable containers

Only those plastic disposable containers which are specified by the manufacturer as suitable for use in a microwave oven may be used.

Do not leave the oven unattended when reheating or cooking food in disposable containers made of plastic, paper or other inflammable materials.

Disposable containers are not always recyclable or bio-degradable.

Testing dishes for their suitability

If in doubt as to whether glass, earthenware or porcelain plates or dishes are suitable for use in a microwave oven, a simple test can be performed:

- Place the item you wish to test in the centre of the oven, fill a suitable glass with water and also place this in the oven.
- Close the door.
- Turn the power selector to 900 Watts.
- Enter a time of 30 seconds with the time selector.
- Press START.

At the end of the test, the water in the small container should be warm but the dish cool. If the dish is very hot and the water is cold, it would be unwise to use the dish.

If a crackling noise is heard accompanied by sparks during the test, switch the appliance off immediately (press button Stop/C twice).

Any crockery which causes this reaction is unsuitable for use in the microwave oven.

If any doubt exists about the suitability of containers, please contact the supplier.

This test cannot be used to check whether items with hollow knobs or handles are suitable for use in a microwave oven.

Accessories

Accessories supplied

A cover

- prevents too much steam escaping, especially when cooking foods which need longer to cook, such as potatoes.
- shortens and evens out the cooking process.
- prevents food from drying out.
- prevents any loss of aroma.

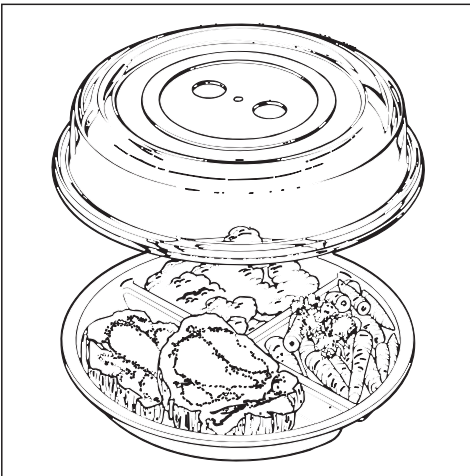

Always cover food with the cover supplied.

Alternatively, use lids or covers made of microwave-safe glass or plastic, or use a clingfilm recommended for use in a microwave oven, (pierce as instructed by the manufacturer).

Normal clingfilm can distort.

Sealed glass containers, such as jars of food and babyfood must be opened before they are placed the oven.

Do not use a lid or cover if

- food coated with breadcrumbs is being cooked
- cooking meals which are to be given a crisp finish.

The cover supplied may only be used in solo microwave operation.

The cover can only withstand temperatures of up to 110 °C. Higher temperatures generated by grilling / fan heat could cause the plastic to distort and fuse with the food.

Grilling rack

The grilling rack is specially designed for use in a microwave oven. It can be used when grilling or using fan grill (with or without the microwave function).

Glass tray

When grilling directly on the rack the glass tray should be placed underneath the rack to catch any fat or juices.

The glass tray is suitable for use with all cooking functions.

Optional accessories

Gourmet plate (MGP 24)

The Gourmet plate is a round grilling plate with an anti-stick coating.

It is available from the Miele Spare Parts Department or your dealer.

Preparation for use

Setting time of day

- Connect the appliance to the mains electricity supply.

“12:00” flashes in the display for approx. 4 seconds and the ⊖ symbol lights up.

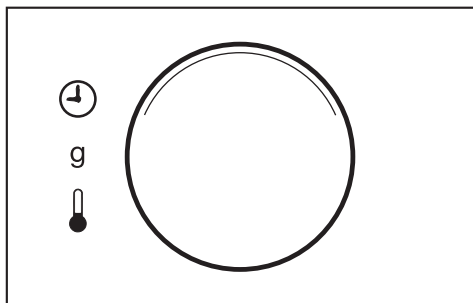

- Use the time selector to set the time of day.

The time set is automatically registered by the appliance after 4 seconds. The colon between hours and minutes flashes.

Altering the time of day

- Press the ⊖ button.
The time of day flashes in the display and the ⊖ symbol lights up.
- Use the time selector to alter the time of day.

Switching off the time of day display

- Press the ⊖ button twice.
The display area goes dark.

Pressing the ⊖ button twice will bring the time of day back in the display.

Night time

The time of day display can be switched off from 23:00 hours until 04:00 hours.

- Press the Stop/C button and hold pressed in while you press the ⊖ button.
DN will appear in the display.
The display is now programmed to switch off at night time.

The appliance can still be operated.



- To cancel, press Stop/C and hold pressed in while you press the ⊖ button.
OFF appears in the display.

Minute minder

The minute minder can be used to time any activity in the kitchen, e.g. boiling eggs. The time set counts down in one second steps.

- Press the △ button.
0:00 flashes in the display and the △ symbol lights up.
- Use the time selector to set the minute minder time you require.
- Press the START button.
- At the end of the minute minder time, an audible tone sounds. The time of day reappears and the △ symbol flashes.
- Press the Stop/C button once and the △ symbol disappears.

Altering a minute minder entry

- Press the Stop/C button.
The minute minder time is interrupted. The time left and the  symbol light up in the display. The Start symbol  flashes.
- Use the time selector to alter the minute minder time and then press the START button.

To open the door

- Press the “” button to open the door.

If the microwave oven is being used, opening the door will interrupt the cooking process.

To close the door

- Push the door firmly shut.

Press the START button to continue an interrupted cooking process.

The appliance will not start again if the door has not been closed properly.

Audible tone

An audible tone sounds after the set times have elapsed.

- Press any button to cancel the tone early.

Safety lock

The safety lock prevents the appliance being used, by children, for example.

To activate the safety lock

- Press and hold the  button in until an audible tone sounds and the key symbol appears in the display:



The key symbol will go out after a short time.

The key symbol reappears whenever any button or one of the rotary selectors is operated.

After an interruption to the mains power supply, the safety lock will need to re-activated.

To cancel the safety lock

- Press the  button again and hold it pressed in until an audible tone sounds.

Operation

Types of operation

Microwave-Solo mode

Suitable for defrosting, re-heating and cooking.

Grill







Ideal for grilling thin cuts of meat, e.g. steak or sausages.

Combination mode - Microwave + Grill

Ideal for cooking and browning dishes with toppings. The microwave cooks the food and the grill browns it.

Automatic programmes

You can choose from the following automatic programmes:

- three automatic defrosting programmes (  )
- two automatic cooking programmes ( )
- and two combination programmes ( )

These programmes are weight dependent. You enter the weight of the food and then the cooking time is calculated automatically.

Microwave-Solo mode

Microwave power settings

There are 7 different microwave power settings to choose from.

The higher the power setting the more microwaves reach the food.

When heating up food which cannot be stirred or turned during cooking, as with a plated meal, it is preferable to use a lower microwave power setting. This ensures the heat is distributed evenly. Heat for long enough to reach the temperature required.

Times for defrosting, reheating, cooking

The time required depends on:

- the initial temperature of the food. Food taken from the refrigerator will need longer to be reheated or cooked than food already at room temperature.
- the type and texture of food. Fresh vegetables contain more water and cook more quickly than stored vegetables.
- the amount of food.

In general:
allow approx. time and a half for double the quantity. For a smaller quantity, possibly shorten the time but ensure food is cooked thoroughly.

- the shape and material of the container.

Placing the container in the oven

Ideally the container should be placed in the middle of the oven.

Turntable

The turntable function starts automatically when the appliance is started.

Food is more evenly cooked, reheated or defrosted with the turntable in operation.

When using the turntable ensure that the dishes or the food to be cooked are not larger in size than the turntable.

It is best not to switch the turntable off. Only switch it off if there is a danger of something blocking it, e.g. a large dish which is wider than the turntable. Press the  button to switch the turntable off.

Make sure that you stir the food during the cooking time or that you turn the food so that it can heat up evenly.

Operation

Starting a process

Use the appropriate selector to choose the microwave power setting and the time. It does not matter which is chosen first.

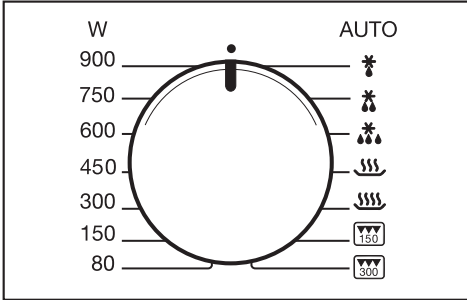

- Turn the power selector to the required setting.
☑ lights up in the display and 0:00 flashes.

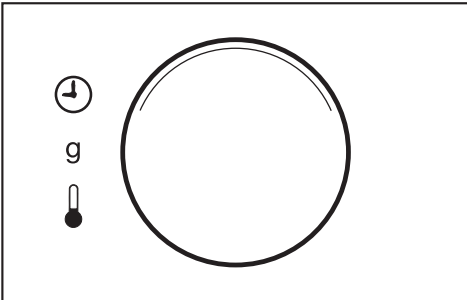

- Set the required time using the time selector.
Any time of between 5 seconds and 60 minutes can be selected.
- Press the START button to start the process.
The interior lighting comes on.

A programme can only be started if the door is closed.

Interrupting a process / Re-starting a process

Programmes can be interrupted and re-started at any time.

- To **interrupt** a process, press the Stop/C button once or open the appliance door.

The time stops counting down.

- To **continue** the process, close the door and press the START button.

The process continues.

Altering settings

If you discover after starting a process that

... the **microwave power setting** is too high or too low, you can

- select a new setting.

... the **time** set is too short or too long, you can

- interrupt the process (press the Stop/C button once), use the time selector to set a new time and continue the process (press the START button).

To cancel a process

Press the Stop/C button twice.

At the end of a process

An audible tone will sound when the cooking process is complete. The oven interior lighting goes out.

Automatic "warming" function

The "warming" function will switch on for a maximum of 15 minutes, approx. 2 minutes after the end of a cooking process which used at least 600 watts, providing that the door remains closed and no buttons are pressed.

H:H and  light up in the display. If the turntable was engaged during a process it will start turning. If it was turned off during the cooking process it will not come on.

Opening the door or pressing the Stop/C button while the "warming" function is in process cancels the function.

"Warming" function

The "warming" function can also be set as a separate function.

- Cover the food with the cover supplied which is designed for use in the microwave

- Press 



 and **H:H** light up in the display.

The "warming" function will continue for a maximum of 15 minutes.

Quick-Start (programmable)

Pressing the START / button is sufficient to set the appliance operating on maximum power.



Three set times are stored in memory:

- 30 s: Press START / once
- 1 min: Press START / twice
- 2 min: Press START / three times

Pressing the START / button four times in succession will bring back the first stored time etc.

Programming times

To programme a different set time:

- Use the START / button to select the relevant set time and hold the START / button pressed in.
- Alter the time with the time selector. The altered time is stored in memory when the START / button is released.

An interruption to the power supply will cancel any altered programmed times and they will need to be entered again.

Operation

Programming the end of cooking time

The duration and end of a process can be pre-programmed. This applies to any method of operation your appliance offers.

- Proceed as for starting a process.
- However at the end do not press the START button. Instead press the →| button.
The time of day will flash in the display. (The programme duration is automatically added).
- Use the rotary selector to enter the time you wish the process to finish. The h symbol flashes, the end time will light up as well as the symbols for the method of operation selected and →| as a symbol for a programmed end of cooking time.
- Press START.
→| and the time of day will light up in the display.

The appliance will switch on automatically and then off at the selected end of cooking time.

If the end of cooking time is programmed for microwave operation make sure that there is food in the oven.

To check the end of cooking time

It is possible to check the end of cooking time before a programmed process has started.

- Press →|, the selected method of operation and the pre-selected end time will appear.

Large cooking dishes

If the dish extends beyond the size of the turntable it might not turn around in the oven. If this is the case the turntable must be switched off.

- Press .

If the door is opened before a starting time has commenced

- Press the ◊ button again after closing the door. The appliance will then start at the pre-selected time.

To change programmed times

- Press the Stop/C button and programme the start time in again.

To delete programmed times

- Press the Stop/C button.

Select the following microwave power settings to reheat food:

Drinks 900 watts
Food 600 watts
Food for babies and toddlers. 450 watts

We do not recommend heating or reheating foods or drinks for babies or young children in the microwave oven. Any decision to do this is the responsibility of the user, and should only be done with the utmost care. Pasteurised or sterilised cooked food should be gently heated at 450 watts, and tasted so that it is not too hot for a baby's palate before serving. Other food or drink when reheated should be heated to a high temperature and allowed to cool to a suitable heat for eating. For made-up milk follow the maker's instructions.

Always use a lid or cover for reheating food, except when a drier finish is needed, e.g. breaded poultry/meat.

Always remove the lids from jars, especially jars of baby food. Remove the rubber teat and seal top before warming baby bottles. When reheating liquids, place the boiling rod supplied with the appliance into the cup or glass. Never reheat hard boiled eggs in a microwave oven, even without the shell. The eggs can burst.

Food taken straight from the refrigerator requires longer to reheat than food stored at room temperature. The time required depends largely on the nature

of the food, its initial temperature and the amount to be cooked.

Always ensure that food is sufficiently cooked or reheated.

If in any doubt that a sufficiently high temperature has been reached, continue reheating for a little longer.

Stir or turn food from time to time during cooking. Stir the food from the outside towards the middle, as food heats more quickly from the outside.

After reheating

Be careful when removing a dish from the oven. It may be hot.

Although heat is not normally produced in the container itself by the microwaves, (apart from stoneware and similar dishes), heat transfer from the food to the container may be considerable, making the container itself hot.

Allow food to stand for a few minutes at room temperature at the end of a reheating process to enable the heat to spread evenly throughout the food.

After heating food, especially food for babies and small children, stir the food or shake the container and check that the temperature does not pose any danger. Double check after it has been left to stand.

Cooking

Place the food in a microwave-safe dish and cover it.

When cooking fresh **vegetables, fish, meat, poultry** first select power setting of 750 watts and then turn it down to 450 watts for more gentle continued cooking.

Vegetable cooking times depend on the texture of the vegetable. Fresh vegetables contain more water than vegetables which have been stored and usually cook more quickly. Add a little water to vegetables which have been kept stored. Stir and turn food at least once during cooking.

Ensure that food, such as meat and fish, are cooked for an appropriate length of time.

For dishes such as **rice or semolina pudding** first select a power setting of 750 watts and then turn down to 150 watts to simmer.

Food with a thick skin or peel, such as tomatoes, sausages, jacket potatoes and aubergines, should be pierced or the skin cut in several places before cooking to allow steam to escape and prevent food from bursting.

Eggs can only be cooked in their shells in the microwave oven in a specially designed egg-boiling device available from specialist shops. Similarly, hard-boiled eggs should not be reheated in the microwave oven as this may lead to the eggs bursting, even once they have been removed from the oven.

Eggs can be cooked without their shells in the microwave oven only if the yolk membrane has been punctured several times first. The pressure could otherwise cause the egg yolk to explode.

Defrosting / Defrosting and reheating / cooking

Defrosting

Remove the food from its packaging and place in a microwave-safe container. Do not cover. Turn, stir or separate the food about half-way through the defrosting time.

To defrost delicate foods, e.g. cream, butter, gateau and cheese, select 80 watts. However to achieve an even result, remove from the oven and finish defrosting at room temperature.

To defrost meat, unpack the frozen meat and lay it on an upturned plate in a glass or china container so that the meat juice can run out, but be collected. Turn half way through defrosting.

For defrosting food such as bread, cakes or fruit, a setting of 150 watts is recommended.

After defrosting

Allow the food to stand at room temperature for a few minutes after defrosting to enable the heat to spread evenly throughout the food.

Defrosting and reheating / cooking

Deep-frozen food can be defrosted and immediately reheated or cooked.

After defrosting select 750 watts followed by 450 watts.

Remove the food from its packaging and place in a covered microwave-safe dish for defrosting and reheating or cooking. Exception: Minced meat should be left uncovered while cooking. Soups, stew and vegetables should be stirred several times during the process. Separate slices of meat half-way through the programme. Turn pieces of meat and fish at the half-way stage.

Deep-frozen pre-cooked meals in cardboard trays which, according to manufacturer's instructions are suitable for use in a conventional oven, are microwave-safe.

If defrosting is followed by reheating or cooking

Allow the food to stand at room temperature for a few minutes to enable the heat to spread evenly throughout the food.

Practical tips

Melting margarine, butter

Melt 100 g at 450 watts uncovered for approx. 1-1 $\frac{1}{2}$ minutes.

Melting chocolate

Break 100 g into pieces, melt at 450 watts uncovered for approx. 2 minutes.

Dissolving gelatine

Add water according to manufacturer's instructions given on the packet and melt at 450 watts for approx. $\frac{1}{2}$ -1 minute, stirring occasionally.

Preparing flan topping / jelly glaze

Gently heat 1 sachet + $\frac{1}{4}$ litre liquid at 450 watts uncovered for approx. 4-5 minutes, stirring occasionally.

Proving dough

(500 g flour) cover and leave to rise for approx. 8-10 minutes at 80 watts.

Skinning tomatoes

Cut 3 tomatoes crosswise, drop into water and heat at 450 watts for approx. 2 minutes. The skin can now be peeled away easily. Take care, the tomatoes may be very hot.

There are three grill settings. Use grill setting 3, the highest setting, when cooking flat pieces of meat just under the grill so that the meat cooks in the shortest time possible. You can change from one grill setting to another at any time during operation.

Do not operate the grill if it has been lowered, e.g. for cleaning. This would damage it.

If the total grilling time required is less than 15 minutes, the grill should be pre-heated for approx. 5 minutes before placing food under the grill.

Flat pieces of fish and meat should usually be turned half way through grilling for even results. Larger pieces should be turned several times.

Grilling times will vary depending on the type of food and how thick it is.

When grilling directly on the rack, the glass tray should be placed underneath the rack to catch any fat or juices.

- Place food on the rack and/or glass tray and then put the rack and/or glass tray into the oven on the required runner level, or place the food directly on the turntable.

Use the 2nd runner from the top for thicker items such as pork chops and the top runner for thinner items such as bacon.

If placing food on the turntable, leave the turntable switched on, to give a more even result.

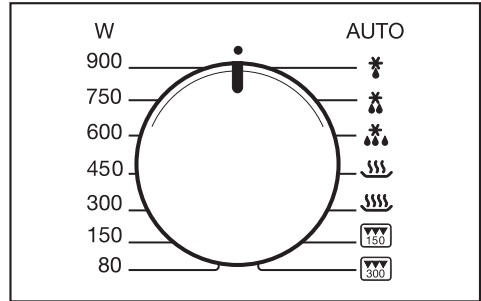

- Turn the power selector to the point (12 o'clock position).
- Press . The grill symbol and 0:00 light up and **GP3** flashes in the display.
- Use the rotary selector to change the grill setting if required.
- A few seconds later 0:00 will flash. The duration can now be set using the rotary selector.

Use the button to alternate between the grill setting and duration.

- Once a grill setting and duration have been selected press START.

An audible tone will sound when the cooking process is complete.

The rack and glass tray become hot during use. Danger of burning!

They will be easier to clean if washed in soapy water immediately after grilling.

Grilling

To change a time

The time entered can be changed during operation by interrupting the process (press the Stop/C button), and changing the time. To continue press the START button.





To change the grill setting

The grill setting can be changed during operation without interrupting the programme. Press , and change the grill setting using the rotary selector.

Combination mode - Microwave + Grill

When used in combination with the microwave function (except with automatic programmes) the grill can be switched on either at the beginning or during cooking. This is useful when food needs to be given a crispy top.

Selecting grilling at the beginning

- Use the power selector to select a microwave power level.
The microwave symbol  lights up in the display and 0:00 flashes.
- Press .
- The grill symbol  and microwave symbol  and 0:00 light up and *GP3* flashes in the display.
- Use the rotary selector to change the grill setting if required.
- A few seconds later 0:00 will flash.
The duration can now be set using the rotary selector.

Use the  button to alternate between the grill setting and duration.

- Once a grill setting and duration have been selected press START.

An audible tone will sound when the cooking process is complete.

The microwave power level, grill setting and duration can be entered in any order.

Switching on the grill after a cooking process has started

Interrupt the process (press Stop/C once), then press , select a grill setting and start the process again (press START).

To switch off the grill



The grill can only be switched off during cooking by cancelling the cooking process (press the Stop/C button twice).

Automatic programmes

The seven automatic programmes are weight dependent. Simply select an automatic programme and then enter the weight of the food.



Automatic defrosting



There are three programmes for defrosting different types of food.

- ☼ Fruit / vegetables  (100 g - 1 kg)
- ☼ Fish / poultry  (100 g - 2 kg)
- ☼ Meat  (100 g - 2 kg)

Automatic cooking



There are two programmes suitable for cooking food weighing from 100 g up to 1 kg.

 Fresh vegetables ,
e.g.: carrots, white cabbage, Brussels sprouts

 Fresh vegetables ,
e.g.: potatoes, courgettes, leeks, spinach, broccoli

Combination programmes

With these programmes the grill works in combination with a microwave power setting of 150 or 300 watts.

-  Poultry  (100 - 1500 g) Grill setting 3
-  Pork  (500 - 1500 g) Grill setting 3

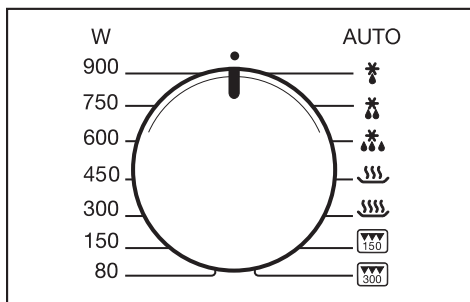

- Turn the selector to the automatic programme you require.
The Start symbol and 100 g flash in the display (500 g with setting ).

- Use the rotary selector to enter the weight.

- Press the START button.

The appropriate time for the weight will begin to count down.

An audible tone will sound half-way through the cooking time.

- Interrupt the programme to turn or stir the food and then continue the programme.

If necessary the programmed times can be altered during the course of a programme (interrupt the programme, alter the time and then continue the programme).

An audible tone will sound when the cooking process is complete.

The oven interior lighting goes out.

Cleaning and care

Disconnect the microwave oven from the power supply before cleaning (e.g. remove the plug from the electrical socket).

Oven housing and interior

The housing and interior can be cleaned using a damp cloth with a little washing up liquid or a mild detergent and water. Wipe dry with a soft cloth.

Avoid too much water as this could penetrate the openings.

Do not use abrasive cleaning agents which could scratch.

Stainless steel surfaces can be cleaned with a proprietary non-abrasive cleaner for stainless steel.

The grill element can be lowered when cool to clean the roof of the oven.

To neutralise odours in the microwave put a cup of water with some lemon juice in the oven and simmer for a few minutes.

For more heavy soiling, heat a glass of water for 2 to 3 minutes until the water begins to boil. The steam will collect on the walls and soften the soiling a little. The oven interior can now be wiped clean using a little washing up liquid if necessary.

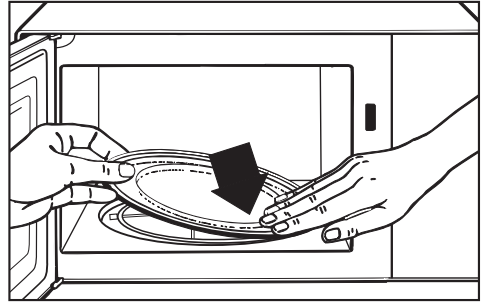

- The turntable can be removed for cleaning.
- Always keep the roller ring underneath it clean as well as the oven floor. Otherwise the ring might not run smoothly.
- Clean the area between the turntable and the carrier. The carrier is located in the middle of the oven floor and can be removed for cleaning.

Do not turn the carrier manually, as this could damage the drive motor.

Door interior

Always keep the door interior clean. Do not use abrasive cleaning agents. Check the door and door seal at regular intervals for any sign of damage. If any damage is noticed, the appliance should not be used until the fault has been rectified by a Miele authorised and trained service technician.

Air vents

Do not let water or any other object find its way into or block the air vents.

Appliance front and control panel

- All external surfaces and controls can be cleaned using warm water with a little washing up liquid applied with a soft sponge or cloth.
- Wipe the surfaces dry using a soft cloth.

E-Cloth

A microfibre "E-Cloth" is available from the Miele UK Spare Parts Department, Part Number 98013530, which is suitable for cleaning surfaces such as stainless steel, glass, plastic and chrome without the use of chemicals. It can be washed 300 times.

To prevent the risk of scratches and damage to the surface of the control panel or glass or stainless steel front of your appliance, please pay particular attention to the following cleaning instructions.

Controls

The controls may suffer discolouration or damage if soiling is left on them for too long. Remove any soiling straight away.

Avoid:

- cleaning agents containing soda, acids or chlorides,
- abrasive cleaning agents, e.g. powder cleaners and cream cleaners,
- abrasive sponges, e.g. pot scourers or sponges which have been previously used with abrasive cleaning agents,

- stainless steel cleaners,
- oven sprays.

Glass fronts

The appliance front and controls are susceptible to scratches and abrasion.

Avoid:

- abrasive cleaning agents, e.g. powder cleaners and cream cleaners,
- abrasive sponges, e.g. pot scourers or sponges which have been previously used with abrasive cleaning agents,
- oven sprays.

Stainless steel fronts

The appliance front and controls are susceptible to scratches and abrasion.

Stainless steel surfaces can be cleaned with a proprietary non-abrasive cleaning agent designed specifically for use on stainless steel.

Avoid:

- cleaning agents containing soda, acids or chlorides,
- abrasive cleaning agents, e.g. powder cleaners and cream cleaners,
- abrasive sponges, e.g. pot scourers or sponges which have been previously used with abrasive cleaning agents.

To help prevent re-soiling, proprietary conditioning agents for stainless steel can also be used. Apply sparingly following the direction of the grain. Wipe dry with a soft cloth.

Cleaning and care

Accessories supplied

Boiling rod

The boiling rod can be washed in a dishwasher.

Cover

The cover can be washed in a dishwasher. However discolouration may occur. Natural dyes, e.g. from carrots, tomatoes or ketchup may be the cause. This discolouration is irreversible but does not affect the stability of the cover.

Side runners

The side runners can be removed for cleaning the side walls of the oven cavity.

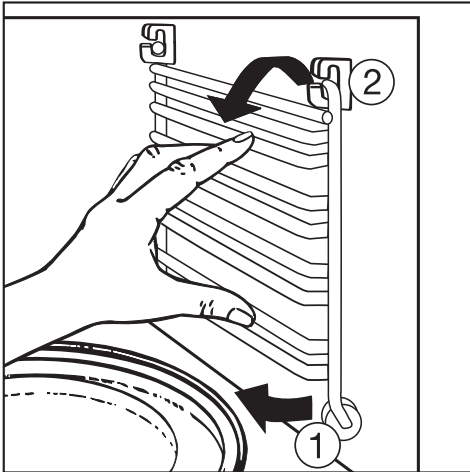

- Pull the bottom of the runners away from the side walls and then pull up and out of the bracket at the top.
- Refit in the reverse order.

Rack, side runners

The rack and side runners should be washed by hand using a solution of hot water and washing up liquid and dried after each use. Remove stubborn soils with a stainless steel cleaner.

Glass tray

The glass tray can be washed by hand using a solution of hot water and washing up liquid or in a dishwasher. Do not use abrasive cleaning agents.

Repairs to this appliance should only be carried out by a Miele approved service technician in accordance with local and national safety regulations. Repairs and other work by unqualified persons could be dangerous. The manufacturer cannot be held liable for unauthorised work.

Some minor problems can be corrected without contacting the Service Department.

What to do if . . .

. . . a process will not start

Check whether:

- The appliance door is closed properly.
- The appliance is plugged into the mains supply.
- The mains fuse has blown (call a qualified electrician or the Service Department if it has. See "After Sales Service").

. . . a noise can be heard at the end of cooking

This is not a fault.

The cooling fan will continue to run for a while after the oven has been switched off to dispel any moisture from the oven and prevent it settling on the control panel or surrounding furniture. It will switch off automatically.

. . . the display does not light up

Check whether:

- The time of day display has been switched off (press the ⊖ button twice).
- The display has been programmed to switch off at night time.

. . . the turntable does not turn smoothly

- Check whether the area underneath the roller ring is soiled.
- Check whether the surfaces between the turntable and the carrier are clean.

Remove any soiling.

. . . food is not adequately defrosted, heated or cooked at the end of the selected time

- Check whether the correct power setting was selected for the time set.
The lower the power setting the longer the time required.
- Check whether the process has been interrupted and not restarted.

. . . strange noises are heard when the microwave oven is being used

Check whether,

- The food is covered with aluminium foil.
If so, remove it.
- Sparks are being created by the use of crockery with a metallic finish. See notes on suitable types of containers.

Problem solving guide

... the time of day in the display is not accurate.

If there has been a power cut lasting longer than a couple of minutes, the time automatically switches back to 12.00.

The time of day needs to be re-set.

- Set the correct time of day.

... food cools down too quickly

In the microwave oven, food begins to cook from the outside first, the inside of the food relying on the slower conduction of heat.

If food is cooked at a high power level it is possible that the heat may not have reached the centre of the food. During standing time heat is transferred to the centre of the food. Food may be warm in the middle but cool on the edge.

When reheating food with different densities, such as plated meals it is sensible to start with a low power level and lengthen the time required.

... the microwave switches itself off during a cooking, reheating or defrosting process

There may be insufficient air circulation.

Check whether,

- The air inlet is blocked.
- An object is blocking the ventilation outlets.
- Anything is blocking the gap between the base of the appliance and the worktop surface.

Remove any objects if necessary. The appliance switches off automatically in the case of overheating. Cooking can be recontinued after a cooling-down period.

If the microwave oven switches itself off repeatedly, please call the Miele Service Department.

If it is not possible to remedy a fault by following the instructions given above, on no account open the appliance casing.

This microwave oven should only be repaired by a suitably qualified technician trained by Miele.

In the event of any faults which you cannot remedy yourself, please contact

- Your Miele Dealer or
- The Miele Service Department (see back cover for address).

When contacting the Service Department, please quote the model and serial number of your appliance given on the data plate which is located externally on the rear wall of the appliance.

Please note that telephone calls may be monitored or recorded to improve our service.

Electrical connection

Before connecting the appliance, ensure that it has not been damaged in any way. Do not use a damaged appliance.

Electrical connection U.K.

All electrical work should be carried out by a suitably qualified and competent person in strict accordance with national and local safety regulations.

The appliance is supplied with a cable and moulded plug ready for connection to a 230-240 V/50 Hz a.c. single phase supply.

The voltage, rated load and fusing are given on the data plate which is located externally on the rear wall of the appliance. Please ensure that these match the household mains supply.

Connection should be made via a fused connection unit or a fused plug and a suitable switched socket, or via a suitable isolator, which complies with national and local safety regulations, and the on/off switch should be easily accessible after the appliance has been installed.

If the socket is not accessible after installation (depending on country) an additional means of disconnection must be provided for all poles.

When switched off there must be an all-pole gap of 3 mm in the isolator switch (including switch, fuses and relays acc. to EN 60335).

For extra safety it is advisable to install a residual current device with a trip current of 30 mA (in accordance with DIN VDE 0664, VDE 0100 Section 739).

If the appliance is connected via an isolator switch the plug must be cut off and rendered useless.

Important

The wires in the mains lead of this appliance are coloured in accordance with the following code:

Green/yellow = Earth
Blue = Neutral
Brown = Live

As the colours of the wires in the mains lead of this appliance may not correspond with the markings identifying the terminals in your plug, proceed as follows:

The wire coloured green and yellow must be connected to the terminal in the plug which is marked with the letter E or by the earth symbol \perp or coloured green or green and yellow.

The wire coloured blue must be connected to the terminal marked with the letter "N" or coloured black. The wire coloured brown must be connected to the terminal marked with the letter "L" or coloured red.

WARNING
THIS APPLIANCE MUST BE
EARTHED

Non-rewireable plugs BS 1363 (UK only)

If this machine or appliance is fitted with a non-rewireable plug, the following information applies: if the socket outlets are not suitable for the plug supplied with this product, it must be cut off and an appropriate plug fitted. The fuse carrier and fuse should be removed from the plug disposed of. The plug cut from the flexible cord should then be disposed of and on no account be inserted into any socket elsewhere in the house (electric shock hazard).

The fuse cover must be re-fitted when changing the fuse, and if the fuse cover is lost the plug must not be used until a suitable replacement is obtained. The colour of the correct replacement cover is that of the coloured insert in the base of the plug, or the colour that is embossed in words on the base of the plug, (as applicable to the design of plug fitted).

The correct rating of the replacement fuses that are ASTA approved to BS 1362 should be fitted. Replacement covers may be purchased from your local electrical supplier, electricity showroom or Miele service agent.

Electrical connection

Electrical connection AUS / NZ

All electrical work should be carried out by a suitably qualified and competent person in strict accordance with national and local safety regulations.

The appliance is supplied with a cable and moulded plug ready for connection to a 230-240 V/50 Hz a.c. single phase supply.

The voltage, rated load and fusing are given on the data plate which is located externally on the rear wall of the appliance. Please ensure that these match the household mains supply.

Connection should be made via a suitable isolator, which should be easily accessible after the appliance has been installed.

For extra safety it is advisable to install a residual current device with a trip current of 30 mA.

AUS / NZ

The plug rating is 15 A.

Test marks Electrical safety
C-Tick Mark

Electrically suppressed
according to AS/NZS 1044

Important

The wires in the mains lead of this appliance are coloured in accordance with the following code:

Green/yellow = Earth
Blue = Neutral
Brown = Live

As the colours of the wires in the mains lead of this appliance may not correspond with the markings identifying the terminals in your plug, proceed as follows:

The wire coloured green and yellow must be connected to the terminal in the plug which is marked with the letter E or by the earth symbol \perp or coloured green or green and yellow.

The wire coloured blue must be connected to the terminal marked with the letter "N" or coloured black. The wire coloured brown must be connected to the terminal marked with the letter "A" or coloured red.

WARNING
THIS APPLIANCE MUST BE
EARTHED

Installation and connection

If the connection cable is damaged the new cable must be fitted by a Miele approved service technician.

Do not position the appliance too close to adjacent furniture. A ventilation gap of at least 5 cm is required around the appliance. The ventilation gap above the appliance should be at least 14 cm.

When installing the appliance ensure there is sufficient ventilation underneath and to the rear of the appliance.

Do not place any objects on the ventilation outlets or block the gap between the base of the appliance and the worktop surface

The microwave oven can be:

- placed on a worktop.
- built into a tall unit or into a unit under a worktop using a suitable building in frame*. The measurements given in its fitting instructions must be observed.
Exception: Appliances with a stainless steel front must not be built-under a worktop.

*Available from your Miele Dealer or the Miele Spare Parts Department.

Technical data

M 635 EG

Voltage (UK, NZ) 220-240 V, 50 Hz
(AUS) 240 V, 50 Hz

Rated load see data plate
Power settings 7 (80/150/300/450/
. 600/750/900 Watt)

Fuse rating (UK) 13 A

Plug rating (AUS, NZ) 15 A

Timer 60 / 90 minutes

Freestanding appliance:

Dimensions (H x W x D) in mm:
Housing 360 x 541 x 430
Nett weight 23 kg

**United Kingdom:**

Miele Co. Ltd.
Fairacres, Marcham Road
Abingdon, Oxon, OX14 1TW
tel. Abingdon (01235) 554455
Service Office: (01235) 554466
fax (01235) 554477
Internet: www.miele.co.uk

Ireland:

Miele Ireland Ltd.
Broomhill Road, Tallaght, Dublin 24
Tel: (01) 46 10 710, Fax: (01) 46 10 797
Email: info@miele.ie
Internet: <http://www.miele.ie>

Australia:

Miele Australia Pty. Ltd.
A.C.N. 005635398
1 Gilbert Park Drive
Knoxfield, VIC 3180
Telephone: (03) 9764 7100
Fax: (03) 9764 7129
Internet: www.miele.com.au

Distributor New Zealand:

Steelfort Engineering Company. Ltd.
500 Rangitikei Street
Palmerston North, Priv. Bag 11045, NZ
Telephone: (06) 350 1350
Fax: (06) 356 1507

South Africa:

Miele (Pty) Ltd
304 Tungsten Road
Strijdom Park 2194
P.O.Box 1654, Randburg 2125
Tel. (011) 793-7452
Telefax (011) 793-7447
E-mail: info@miele.co.za
Internet: www.miele.co.za

Singapore:

Miele Southeast Asia
Miele Pte. Ltd.
163 Penang Road
04 - 02/03 Winsland House II
Singapore 238463
Tel : +65-67351191
Fax: +65-67351161
Email: mielesea@miele.com.sg

Hong Kong:

Miele (Hong Kong) Limited
AIA Plaza, Room 401, 4th Floor
18 Hysan Avenue
Causeway Bay
Hong Kong
Tel.: (852) 2610 1331
Fax: (852) 2610 1013
E-mail: mielehk@netvigator.com